



The Fletcher-Terry Company

# OWNER'S MANUAL

---

## Fletcher *Substrate Cutter* (FSC)

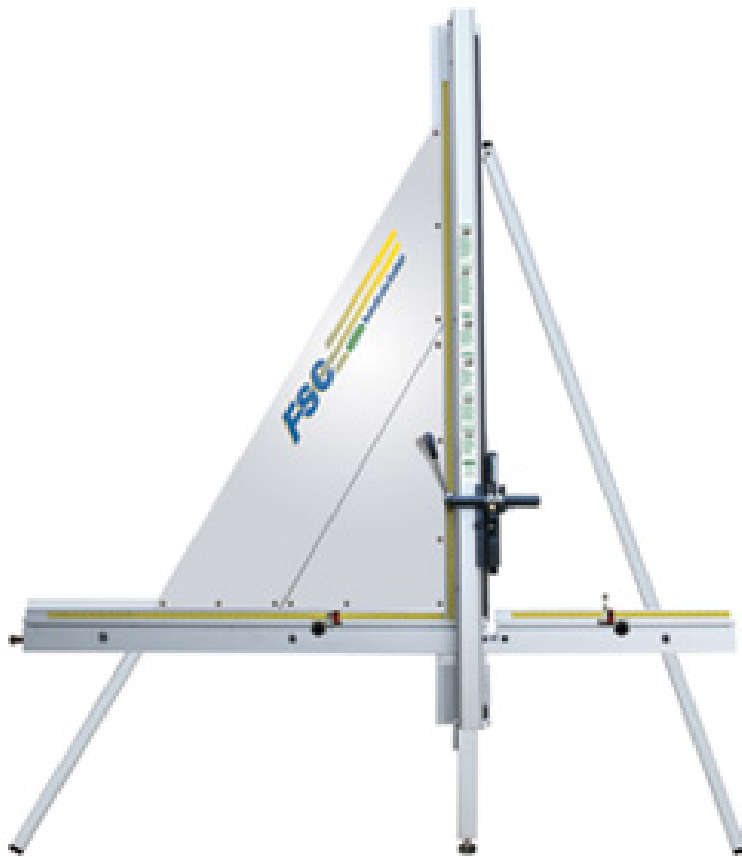

### The Fletcher-Terry Company

65 Spring Lane • Farmington, CT USA 06032-3311

Tel 860.677.7331 • Toll-Free 888.888.5165 • Fax 860.676.8858 • [customerservice@fletcher-terry.com](mailto:customerservice@fletcher-terry.com) • [www.fletcher-terry.com](http://www.fletcher-terry.com)

FORM ENG-033109

**INTRODUCTION**..... iv

**PRODUCT WARRANTY**..... iv

**SAFETY FIRST** ..... v

**I. INSTALLATION**

1. Unpacking the FSC  
    A. Contents Include ..... 1  
    B. Hardware List ..... 2

2. Terminology for Set-Up ..... 3

3. Pre-Assembly ..... 3

4. Positioning the Vertical Track Assembly ..... 4

5. Removing the Rear Leg (Wall-Mount Only) ..... 4

6. Connecting the Rear Leg (Wall-Mount Only) ..... 5

7. Attaching the Rear Leg to the Wall ..... 5

8. Attaching the Horizontal Brace Channel ..... 6

9. Attaching the Left Leg to the Horizontal Brace Channel ..... 6

10. Assembling the Right Leg and the Rear Horizontal Brace ..... 7

11. Connecting the Rear Leg (Free-Standing Unit Only) ..... 8

12. Securing the Frame ..... 8

13. Preparing the FSC for Wall-Mounting (Wall-Mounted Unit Only) ..... 9

14. Attaching the Front Center Leg ..... 9

15. Adjusting the Front Center Leg ..... 9

16. Mounting the Face Plates ..... 10

17. Securing the Face Plate to the Left Frame Leg ..... 11

18. Installing the Horizontal Material Bar ..... 11

19. Securing the Wall-Mounted Unit (Wall-Mounted Unit only) ..... 12

20. Inserting the Production Stops ..... 12

21. Mounting the Tool Caddy ..... 13

22. Squaring the FSC ..... 13

23. Setting the Scales ..... 13

24. Adjust Vertical Track/Clamp Assembly ..... 13

## II. USING CUTTING TOOLS AND SUBSTRATES

25. Cutting Blades and Wheels	
A. ¼" (7mm) Blade Holder (optional) .....	16
B. ½" (13mm) Blade Holder.....	16
C. Acrylic Blade Holder.....	16
D. Glass Scoring Wheel Holder (optional).....	16
E. Aluminum Sheet Wheel Holder (optional).....	16
F. Aluminum Composite Wheel Holder.....	16
26. Installing New Cutting Blades/Wheels/Scoring Tips into Holders	
A. ½" (13mm) or ¼" (7mm) Blade .....	17
B. Cutting Wheels.....	17
C. Acrylic Blade .....	17
D. Glass Scoring Wheel.....	17
27. Cutting Techniques for Various Substrates	
A. Cutting Foamboard/Gatorboard .....	18
B. Cutting PVC and Corrugated Plastic.....	18
28. Scoring and Breaking Techniques for Fracture-Sensitive Material	
A. Scoring Fracture-Sensitive Material and Polycarbonate.....	19
B. Breaking Fracture-Sensitive Material.....	19
29. Cutting Solid Aluminum/Aluminum-Faced Sheet Material .....	19
30. Proper Glass Scoring and Breaking Techniques	
A. Scoring Glass.....	20
B. Breaking Glass Along a Score Line .....	20

## III. OPERATING THE FSC

31. Inserting the Cutting Tool in the Cutting Head .....	21
32. Securing the Material.....	21
A. To Open .....	19
B. To Close.....	19
33. Positioning the Substrate.....	21
34. Using the Production Stops.....	22
35. Making a Cut or Score Line with the FSC	
A. Creating a Cut Line .....	22
B. Using a Blade to Create a Score Line.....	22
36. Locking the Rocker Arm .....	23

#### IV. **INSTALLING THE LASER**

37. Setting Up the Laser .....	24
38. Mounting the Laser to the FSC.....	24
39. Dual Position Laser .....	24
A. Positioning the Laser for Use with the Wheel .....	26
B. Positioning the Laser for Use with the Blade .....	26
40. Creating the Score Lines for Calibrating the Laser .....	25
41. Calibrating the Laser to Cut Lines	
A. Creating a Continuous Laser Beam.....	26
B. Setting the Angle of the Laser Beam .....	26
42. Securing the Blade Cutting Laser Position.....	27
43. Securing the Cutting Wheel Laser Position.....	28

#### V. **MAINTENANCE, ADJUSTMENTS, TROUBLESHOOTING & FAQ**

44. General Maintenance Tips	
A. Cleaning .....	29
B. Adjusting the Rocker Arm .....	29
C. Adjusting the Cutting Head Bearings.....	29
D. Replacing the Cutting Head Bearings.....	30
E. Removing the Cutting Head.....	30
F. Removing the Bearings.....	30
45. Troubleshooting Your FSC .....	31
46. Frequently Asked Questions	
A. Materials.....	32
B. Cutting .....	33

#### VI. **REPLACEMENT PARTS LIST AND SCHEMATICS** ..... 34

**NOTE: Our Replacement Parts List and Schematics are in the final stages and will be posted on our website ([www.fletcher-terry.com](http://www.fletcher-terry.com)) when they become available. In the meantime, if you need technical support, contact our customer service department at:**

**888.888.5165 (in the United States)  
++860.677.7331 (outside the United States)  
email - [customerservice@fletcher-terry.com](mailto:customerservice@fletcher-terry.com)**

## **Introduction**

Thank you for purchasing the Fletcher Substrate Cutter (FSC). Our history of quality, our reputation for innovation, and our superior customer service combined with this amazing product, is designed to make your business more profitable than you ever imagined.

We want your experience using the FSC to be exceptional, so for maximum safety and productivity, **please read and understand this manual thoroughly before you operate your new Fletcher Substrate Cutter.**

## **Product Warranty**

The Fletcher-Terry Company warrants the machine purchased to be free from defects in parts and workmanship for one (1) year from the date of purchase. The Fletcher-Terry Company warrants that it will repair or replace any such defective machine or replace parts, providing the machine has been under normal use and service and the defective part or machine is returned to the Fletcher-Terry Company at the purchaser's expense. The Fletcher-Terry Company must authorize the return in writing. Proof of purchase must be submitted to validate warranty coverage. The warranty is in lieu of all other agreements and warranties expressed or implied.

THE FLETCHER-TERRY COMPANY DOES HEREBY EXPRESSLY DISCLAIM ANY WARRANTIES OF MERCHANT ABILITY OR FITNESS FOR A PARTICULAR PURPOSE. The Fletcher-Terry Company does not authorize any company employee or representative to assume for it any other liability than that set forth in this Product Warranty. The Fletcher-Terry Company shall not be liable for any damages or losses, whether incidental or consequential or direct or indirect, arising out of the use or abuse of this machine. The Warranty is valid only when the machine is used with Fletcher consumables and replacement parts. In any event, THE PURCHASER'S SOLE AND EXCLUSIVE REMEDY UNDER THIS OR ANY OTHER WARRANTY IS LIMITED TO RETURN OF THE PURCHASE PRICE PAID FOR THIS MACHINE.

# SAFETY FIRST!

Please read through this manual before operating the Fletcher Substrate Cutter (FSC). If after reviewing these pages you still have questions about using the machine, contact our Customer Service Department toll-free at 888.888.5165 in the United States. Outside the United States, call ++860.677.7331 or email [customerservice@fletcher-terry.com](mailto:customerservice@fletcher-terry.com).

- It is the employer's responsibility to enforce compliance with these safety warnings and procedures by all who use the FSC. Keep this manual available so all employees who have access to it and have the opportunity to review procedures periodically.
- The intended purpose of the FSC is to cut substrates for use in sign-making. It must not be modified or used for any other application or purpose.
- The FSC is for use in cutting aluminum (up to .063" [1.5mm] maximum thickness), aluminum faced (1/4" [7mm] maximum thickness), PVC (1/2" [13mm] maximum thickness), corrugated plastic (1/2" [13mm] maximum thickness), polycarbonate (1/4" [7mm] maximum thickness), and acrylic substrates and glass. Do not attempt to cut wood with the Fletcher Substrate Cutter.
- Use safety glasses. The operator of this machine, and others in the work area, must wear safety glasses with rigid side shields.
- When lifting the Vertical Track Assembly into place, **DO NOT TRY TO LIFT IT ALONE**, as the weight of the assembly could cause injury. Make sure someone is available to help you lift it.
- Only use the parts, supplies, and accessories that are recommended by Fletcher-Terry.
- Do not over-reach or use the FSC from an awkward or insecure position. Make sure that the work area is well lit, free from clutter, and setup in a way that promotes proper ergonomics.
- **IF YOU TURN ON THE LASER SIGHT MAKE SURE TO ALWAYS USE PROTECTIVE LASER GLASSES** (*glasses are not included with machine purchase*). **DO NOT ATTEMPT TO OPERATE THE FSC WITHOUT YOUR PROTECTIVE GLASSES.**

# Installation

## I. Installation of the FSC

### 1. Unpacking the FSC

Check the exterior of the packing box to make sure there is no visible damage. After unpacking the unit, check to make sure all the parts are present and undamaged.

#### A. Contents Include:

- Partially Pre-Assemble Framing Vertical Track/Anvil Assembly
- Frame Parts (*see **Frame Parts below***)
- Box #1\* - Tool Caddy
  - ✓ Tool Caddy
  - ✓ 2 Screws and Washers
- Box #2\* - Laser and Bracket Assembly
- Box #3 - Holders, Stops, and Machine Hardware Box
  - ✓ 3 Blade/Wheel Holders
  - ✓ 2 Production Stops
  - ✓ 4 Hex Keys
- Box #4 - Frame/Stand Hardware Box (*see **Figure on page 2***)

\* box is not labeled with number

#### Frame Parts

- |                          |                             |
|--------------------------|-----------------------------|
| 1. Large Face Plate      | 5. Horizontal Material Bar  |
| 2. Center Adjustable Leg | 6. Rear Horizontal Brace    |
| 3. Left Leg Bottom       | 7. Horizontal Brace Channel |
| 4. Right Leg Bottom      | 8. Small Face Plate         |



# Installation

## B. Hardware List

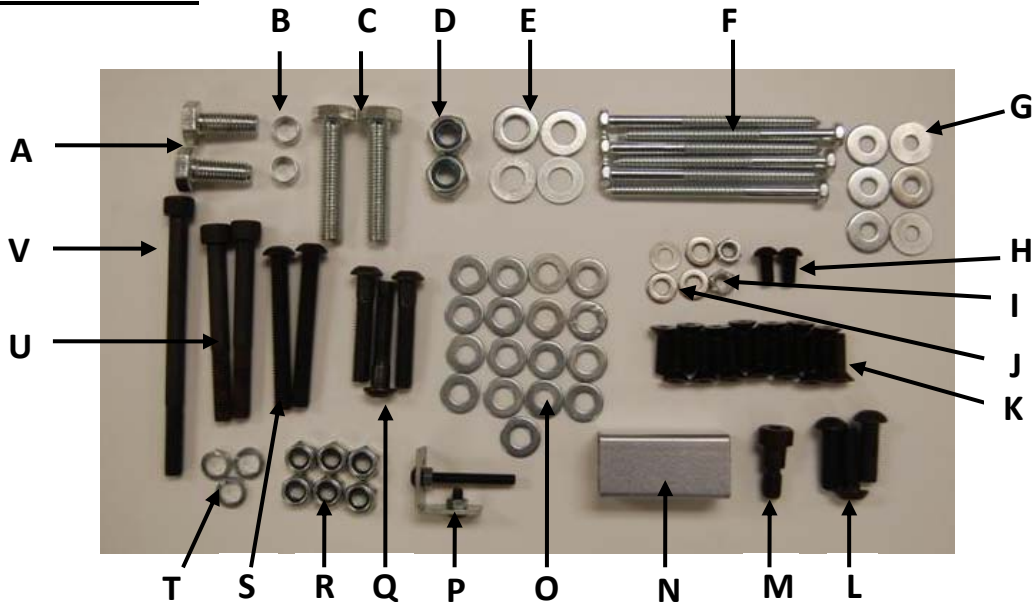

Item	Qty	Hardware Description	Assembly Section	Pg
A	2	M10 x 25mm Hex Head Bolt	Rear Leg to Rear Mounting Bracket	8
B	2	M10 Sleeve	Rear Leg to Rear Mounting Bracket	8
C	2	M10 x 50mm Hex Head Bolt	Center Adjustable Leg	9
D	2	M10 Hex Lock Nut	Center Adjustable Leg	9
E	4	M10 Flat Washer	Center Adjustable Leg	9
F	6	M6 x 100mm Lag Bolt	Wall Mount Rear Leg	5
G	6	M6 Flat Washer	Wall Mount Rear Leg	5
H	2	M6 x 12mm Button Head Screw	Connect Face Plates	10
I	2	M6 Hex Nut	Connect Face Plates	10
J	2	M6 Flat Washer	Connect Face Plates	10
K	14	M6 x 20mm Flat Head Screw	Horizontal Brace Channel & Face Plates	6 & 10
L	3	M8 x 25mm Button Head Screw	Horizontal Material Bar	11
M	1	Pivot Shoulder Bolt	Horizontal Material Bar	11
N	1	Square Spacer	Horizontal Material Bar and Right Leg	11
O	17	M8 Flat Washer	As noted in details.	
P	1	Large Face Plate Bracket M5 x 10mm Button Head Screw M5 x 40mm Button Head Screw M5 Hex Nuts	Face Plate to Left Leg	10 & 11
Q	3	M8 x 50mm Button Head Screw	Left Leg to Horizontal Brace Channel Right Leg Bottom	6 7
R	6	M8 Hex Lock Nut	As noted in details.	
S	2	M8 x 70mm Button Head Screw	Rear Leg	5
T	3	M8 Lock Washer	As noted in details.	
U	2	M8 x 80mm Socket Cap Screw	Rear Horizontal Brace to Right and Left Leg	7
V	1	M8 x 110mm Socket Cap Screw	Horizontal Material Bar to Right Leg	11



# Installation

## ◆ Notes:

- To assemble the FSC, you will need a cleared workspace approximately 10'x10'.
- All views mentioned for the assembly of the FSC are from the perspective of the customer facing the standing machine.
- All bolts are inserted from left-to-right, or from front-to-back.

## 2. Terminology for Set-Up

The Vertical Track Assembly has been assembled for you. Familiarize yourself with the main parts of the pre-assembled unit.

**Vertical Track Assembly** – the plane that the blade moves along.

**Cutting Head** – holds the cutting tool and moves along the Vertical Track Assembly.

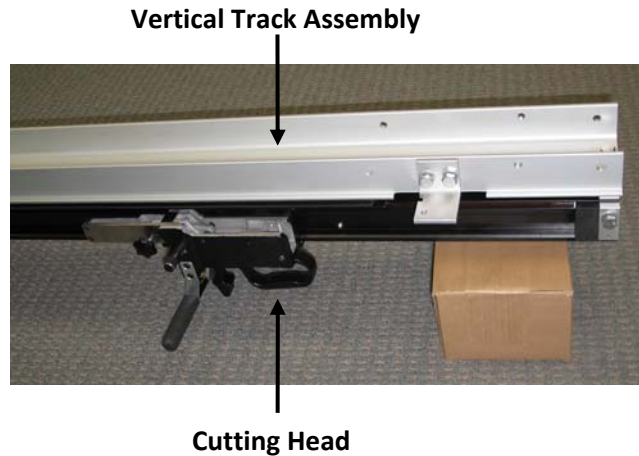

## 3. Pre-Assembly

In order to make your assembly of the FSC as easy as possible, organize your workspace so you have all the necessary tools and parts at hand.

1. Match up the screws and bolts with the correct number of washers and their nuts (**see *Hardware List, Section 1.-B. on page 2 for detailed list***).
2. Arrange the tools needed to complete the assembly.
  - a. 3mm, 4mm, 5mm, and 6mm Hex Key
  - a. 8mm, 10mm, 13mm, and (2) 17mm Wrenches
  - b. 2-3 boxes approximately the same height
  - c. Flat Head Screwdriver
  - d. Drill (wall-mounted unit only)
  - e. Carpenter's Level (wall-mounted unit only)

At the beginning of each section there is a “Parts Needed” list. Have these items close at hand as they will be needed in the assembly of that section.

# Installation

## 4. Positioning the Vertical Track Assembly

### Parts Needed:

Tools
Two boxes approximately the same height

➤ **Tip:** You can use the Tool Caddy Box and the Laser Box included with the FSC as supports.

1. Lift the Vertical Track Assembly out of the box, and place it on the workroom floor.



**CAUTION:** To protect against personal injury, two people should lift the pre-assembled unit.

2. Grasp the black handle of the Cutting Head, and slide it up to the top of the Vertical Track Assembly.
3. Lock the Cutting Head in position by turning the black knob to the right (black knob is located to the left of the handle).
4. Position one of the boxes next to the top of the Vertical Track Assembly.
5. Carefully turn the Vertical Track Assembly over so it is resting on the box (*see Figure on page 3*).

◆ **Note:** It is important that the Cutting Head is completely off the floor. The weight of the machine can damage the Cutting Head.

◆ **Note:** If your FSC is to be a free-standing unit, please proceed to “Attaching the Horizontal Brace Channel” on page 6.

## 5. Removing the Rear Leg (Wall-Mount Only)

### Parts Needed:

Tools
Two (2) 17mm Wrenches

1. Using two (2) 17mm Wrenches, remove the M10 Hex Bolts from either side of the top of the Rear Leg Mounting Bracket. Set them aside for later use.
2. Remove the Rear Leg by sliding the top off of the Vertical Track Assembly.
3. Locate the long M10 Hex Bolt that is connecting the two Front/Back Support Braces to the bottom portion of the Rear Leg.
4. Using two 17mm Wrenches, remove the M10 Hex Bolt and set aside.
5. Fold the Front/Back Support Braces up, and lay them inside the Vertical Track Assembly.
6. Using the long M10 Hex Bolt you just removed, secure the Front/Back Support Braces to the Vertical Track Assembly by inserting the Bolt through the aligned holes at the top of the Braces.

# Installation

## 6. Connecting the Rear Leg (Wall-Mount Only)

### Parts Needed:

Frame Parts	Qty.	Hardware	See Pg 2	Tools Needed
Rear Leg	2	M8 x 70mm Button Head Screw	S	5mm Hex Key
(Top and Bottom)	4	M8 Flat Washer	O	13mm Wrench
	2	M8 Hex Lock Nut	R	

1. Slide the bottom portion of the Rear Leg onto the top portion.
2. Locate the two (2) holes on the side at the center of the leg.
3. Install the two (2) M8 x 70mm Button Head Screws with the four (4) Flat Washers (one on each side), and two (2) Hex Lock Nuts.
4. Tighten the Bolts with a 5mm Hex Key and 13mm Wrench.

## 7. Attaching the Rear Leg to the Wall

### Parts Needed:

Frame Parts	Qty.	Hardware	See Pg 2	Tools Needed
Rear Leg	6	M6 Lag Bolt	F	Drill
(Assembly)	6	M6 Flat Washer	G	Pencil Carpenter's Level

1. Locate a vertical stud on the wall where you want to install the FSC.
- ◆ **Note: Find a wall location where there will be plenty of room on either side of the wall stud to feed and remove the sheet material. If you cannot find a vertical structural stud, or your wall construction is a solid material (i.e. masonry, concrete, etc.), you will need to install the appropriate wall anchors for the Lag Bolts.**
2. Locate and mark the center of the stud at the height of the Rear Leg.
3. Mark a location in the center of the stud by the floor as well.
4. Place the Rear Leg against the wall, centering the Leg on the marks you just created.
5. Using a Carpenter's Level, check the straightness, and adjust the Rear Leg until it is straight.
6. Holding the Rear Leg in position, mark the wall through the six (6) mounting holes using a pencil or other pointed tool.
7. Set the Rear Leg aside.
8. Drill a pilot hole in each of the six (6) marked locations. Select a proper drill size based on wall material.
9. Reposition the Rear Leg over the holes.
- ◆ **Note: The Rear Leg Mounting Bracket should be up against the wall.**
10. Secure the Leg to the wall using the six (6) M6 Lag Bolts and six (6) M6 Flat Washers.



**CAUTION: The Rear Leg must be firmly secured to the wall to prevent injury.**

# Installation

## 8. Attaching the Horizontal Brace Channel

### Parts Needed:

Frame Parts	Qty.	Hardware	See Pg 2	Tools Needed
Horizontal Brace Channel (Page 1 - #7)	2	M6 x 20mm Flat Head Screw	K	4mm Hex Key

1. Locate the two (2) holes at the bottom, right-hand side of the Vertical Track Assembly as viewed from the back of the machine (*see Figure on the right*).
2. Lay the left end of the Horizontal Brace Channel over the holes on the Vertical Track Assembly so all the holes line up.
3. Position a second box under the right side of the Horizontal Brace Channel for support.
4. Insert two (2) M6 Flat Head Screws through the holes from the front of the machine (this will mean going from underneath) using your fingers.
5. Tighten only the bottom Screw using a 4mm Hex Key. You will be removing the top Screw later.

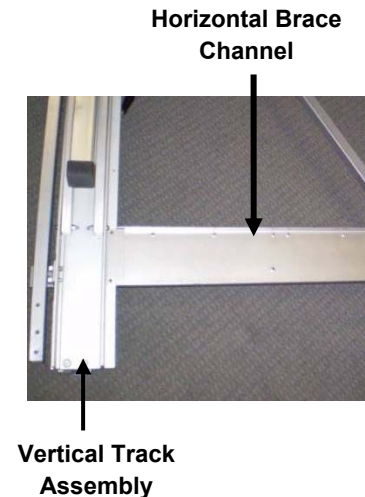

## 9. Attaching the Left Leg to the Horizontal Brace Channel

### Parts Needed:

Frame Parts	Qty.	Hardware	See Pg 2	Tools Needed
Left Leg Bottom (Page 1 - #3)	2	M8 x 50mm Button Head Screw	Q	5mm Hex Key
	2	M8 Lock Washer	R	

1. Locate the Left Leg top-mounted to Vertical Track Assembly.

◆ **Note: Remember you are looking at the back of the machine so the Left Leg is on your right.**

2. Open the Left Leg by pulling it to the right.
3. Slide the Left Leg Bottom into the Left Leg Top.
4. Position the Leg over the Horizontal Brace Channel Bracket on the back of the Horizontal Brace Channel.
5. Align the top two (2) open holes on the Left Leg with the holes on the Horizontal Brace Channel Bracket.
6. Attach the Left Leg Assembly to the Horizontal Brace Channel Bracket using two (2) M8 Button Head Screws and two (2) M8 Lock Washers.
7. Tighten with a 5mm Hex Key.

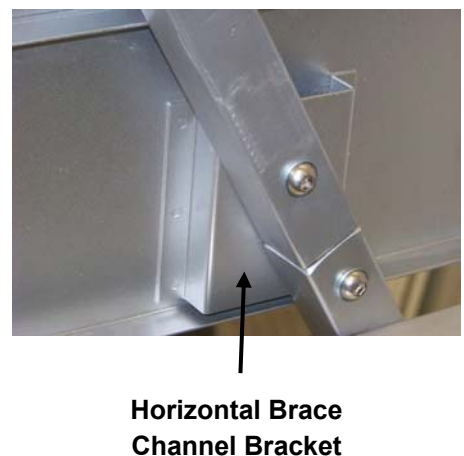

# Installation

## 10. Assembling the Right Leg and the Rear Horizontal Brace

### Parts Needed:

Frame Parts	Qty.	Hardware	See Pg 2	Tools Needed
Right Leg Bottom (Page 1 - #4)	2	M8 x 80mm Socket Cap Screw	U	6mm Hex Key
	2	M8 Flat Washer	O	
	2	M8 Hex Lock Nut	R	
Rear Horizontal Brace (Page 1 - #6)	1	M8 x 50mm Button Head Screw	Q	13mm Wrench
	2	M8 Flat Washer	O	
	1	M8 Hex Lock Nut	R	

1. Locate the Right Leg top-mounted on the Vertical Track Assembly.
2. Open the Leg by pulling it to the left.

➤ **Tip: Place the Leg on a box for better support.**

3. Slide the Right Leg Bottom onto the bottom of the opened Right Leg Top.
4. Position and align the Rear Horizontal Brace over the lowest available hole on the Left Leg, and the middle hole on the Right Leg.
5. Attach the Legs to the Rear Horizontal Brace using two (2) M8 x 80mm Socket Cap Screws, four (4) Flat Washers (one on each side), and two (2) Hex Lock Nuts. Tighten with a 6mm Hex Key and 13mm Wrench.

◆ **Note: Remember to insert the screws from the front of the machine.**

6. Locate the Leg Mounting Brackets positioned at the top of each leg.
7. Tighten the Screws on the Mounting Bracket using a 5mm Hex Key and 13mm Wrench.
8. Install one (1) M8 x 50mm Button Head Screw, two (2) Flat Washers (one on each side), and one (1) Hex Lock Nut through the hole on the Right Leg under the Rear Horizontal Brace.
9. Tighten the Screw using a 5mm Hex Key and 13mm Wrench.

◆ **Note: For Wall-Mounting, skip to “Preparing the FSC for Wall-Mounting” - Section 13 on page 9.**

Leg Mounting Brackets



# Installation

## 11. Connecting the Rear Leg (Free-Standing Unit Only)

### Parts Needed:

Frame Parts	Qty.	Hardware	See Pg 2	Tools Needed
Lower Rear Leg	2	M10 x 25mm Hex Head Bolt	A	5mm Hex Key 13mm Wrench
	2	M10 Sleeve	B	
	2	M8 x 70mm Button Head Screw	S	
	4	M8 Flat Washer	O	
	2	M8 Hex Lock Nut	R	

1. Insert two (2) M10 Bolts with two (2) Sleeves to either side of the Rear Leg Mounting Bracket.
2. Tighten the Bolts with your fingers.
3. Open the Rear Leg by pulling up on each portion of the leg.
4. Slide the bottom portion of the Rear Leg into the top portion.
5. Locate the two (2) holes on the side of the center of the leg.
6. Install two (2) M8 x 70mm Button Head Screws, four (4) Flat Washers (one on each side), and two (2) Hex Lock Nuts from the left side of the machine.
7. Tighten the Screws with a 5mm Hex Key and 13mm Wrench.

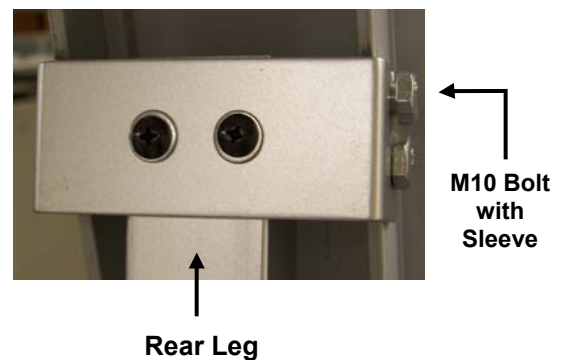

## 12. Securing the Frame

### Parts Needed:

Tools Needed
17mm Wrench
13mm Wrench
5mm Wrench

1. Tighten all four (4) Rear Leg Mounting Bracket Bolts using a 17mm Wrench.
2. Tighten all Front/Back Support Brace Bolts. Use a 17mm Wrench for the Rear Leg Bolts, and a 13mm Wrench and 5mm Hex Key for the Center Leg bolts.

◆ **Note:** For Free-Standing FSC, skip to Section 14, “Attaching the Front Center Leg” on page 9.

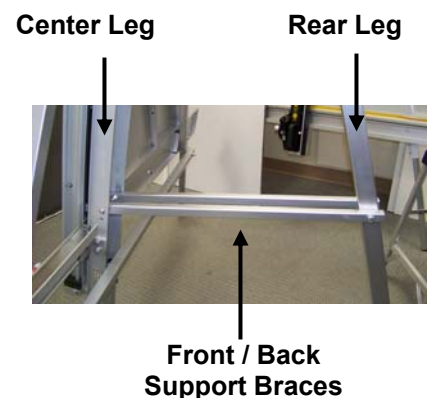

# Installation

## 13. Preparing the FSC for Wall-Mounting (Wall-Mounted Unit Only)

### Parts Needed:

Frame Parts	Qty.	Hardware	See Pg 2	Tools Needed
	2	M10 x 25mm Hex Head Bolt	A	Carpenter's Level
	2	M10 Sleeve	B	

1. Insert the two (2) M10 Bolts with Sleeves into the top most holes on either side of the Vertical Track Assembly.
2. Lift up the assembled FSC, and nest the two (2) Bolts in the grooves on the Rear Leg Mounting Brace.



**CAUTION:** To avoid personal injury, two people should lift the assembled FSC.

## 14. Attaching the Front Center Leg

### Parts Needed:

Frame Parts	Qty.	Hardware	See Pg 2	Tools Needed
Center Adjustable Leg (Page 1 - #2)	2	M10 x 50mm Hex Head Bolt	C	(2) 17mm Wrenches
	4	M10 Flat Washer	E	
	2	M10 Hex Lock Nut	D	

1. Align the holes at the top of the Center Adjustable Leg with the holes at the bottom, left side of the Vertical Track Assembly.
2. Attach the Center Adjustable Leg to the **inside** of the Vertical Track Assembly using the two (2) M10 x 50mm Hex Bolts, four (4) Flat Washers (one on each side) and two (2) Hex Lock Nuts.
3. Tighten the Bolts using two (2) 17mm Wrenches. Position one on the Bolt and one on the Hex Lock Nut and turn in the opposite directions to tighten.
4. Pick up the FSC, and place it on its feet.

◆ **Note:** If you notice any rattling, review the previous steps, and tighten any missed bolts.

## 15. Adjusting the Front Center Leg

The Center Leg can be adjusted to be longer or shorter by turning the black Foot left or right. The Foot has a round ball end for ease of adjustment when contacting the floor. It can be locked into place by tightening the Lock Nut.

# Installation

## 16. Mounting the Face Plates

### Parts Needed:

Frame Parts	Qty.	Hardware	See Pg 2	Tools Needed
Small Face Plate (Page 1 - #8)	13	M6 x 20mm Flat Head Screw	K	4mm Hex Key
Large Face Place (Page 1 - #1)	2 4 2	M6 x 12mm Button Head Screw M6 Flat Washer M6 Hex Nut	H J I	10mm Wrench
Large Face Plate Bracket	1	Hardware is attached to bracket	P	3mm Hex Key 8mm Wrench

1. Remove the top Screw connecting the Horizontal Brace Channel to the Vertical Track Assembly.
2. Position the Small Face Plate so it is nesting in the right angle made by the Horizontal Brace Channel and the Vertical Track Assembly.
3. Align the holes.
4. Attach the Small Face Plate using seven (7) M6 x 20mm Flat Head Screws.
5. Loosely tighten the Screws with your fingers.
6. Locate the Large Face Plate Bracket.
7. Remove the two (2) Screws that are attached.
8. Align the vertical hole of the Bracket and the hole at the center of the long side of the Large Face Plate.
9. Insert the M5 x 10mm Button Head Screw (already included on the Large Face Place Bracket). Tighten the M5 Nut and Washer using a 3mm Hex Key and 8mm Wrench.
10. Nest the Large Face Plate up against the Small Face Plate so the top diagonal of the Small Face Plate is in contact with the bottom diagonal of the Large Face Plate.
11. Attach the top of the Large Face Plate to the Vertical Track Assembly first, then the lower portion to the Horizontal Brace Channel using six (6) M6 x 20mm Flat Head Screws.
12. Tighten all the Face Plate Screws using a 4mm Hex Key.
  - **Tip: Reposition the Clamp Handle for easier access to the screws.**
13. Secure the two Face Plates together by using two (2) M6 x 12mm Button Head Screws, four (4) Flat Washers (one on each side), and two (2) M6 Hex Nuts in the aligned holes on the back of the Face Plates.
  - **Tip: For Wall-Mounted Units: If you need more working room behind the machine, remove the long M10 Hex Head Bolt holding the Front/Back Support Bars. Lower the bars, so they push the assembled FSC away from the wall. Remember to reposition the Bolt when you are done.**
14. Use a 4mm Hex Key and 10mm Wrench to tighten.



# Installation

## 17. Securing the Large Face Plate to the Left Frame Leg

### Parts Needed:

Hardware	Tools Needed
M6 x 40mm Button Head Screw (was attached to Bracket "P')	3mm Hex Key 8mm Wrench

1. Insert the M6 x 40mm Button Head Screw, M6 Flat Washer, and M6 Hex Nut that came with the Bracket to secure the Large Face Plate to the Left Leg.
2. Tighten the Screw using a 3mm Hex Key and 8mm Wrench.

## 18. Installing the Horizontal Material Bar

### Parts Needed:

Frame Parts	Qty.	Hardware	See Pg 2	Tools Needed
Horizontal Material Bar (#5 – Pg 1)	3	M8 x 25mm Button Head Screw	L	5mm Hex Key
	3	M8 Flat Washer	O	
	1	Pivot Shoulder Bolt	M	
Square Spacer (N – Pg 2)	1	M8 x 110mm Socket Cap Screw	V	6mm Hex Key 13mm Wrench
	2	M8 Flat Washer	O	
	1	M8 Hex Lock Nut	R	

### ◆ Note: Release the Clamp, if you repositioned it in the previous step.

1. Locate the opening between the Clamp Assembly and the Vertical Track Assembly. This is where the Horizontal Material Bar will be positioned.
2. Slide the Horizontal Material Bar in the opening from the **right side** of the machine below the Clamp mechanism.
3. Pull the Horizontal Material Bar all the way over to the left until it is resting on the Squaring Ramp.

### ◆ Note: The notch of the Horizontal Material Bar will be positioned in the notch of the Vertical Track Assembly.

4. Lift at the center of the Horizontal Material Bar to align the holes between the Horizontal Material Bar and the Horizontal Brace Channel.
5. Insert the Pivot Shoulder Bolt into the hole directly to the right of the Vertical Track Assembly.
6. Tighten using a 5mm Hex Key.
7. Insert the three (3) M8 x 25 Button Head Screws with three (3) Flat Washers starting from the far left of the Horizontal Material Bar.

➤ **Tip: Make sure the Horizontal Material Bar is positioned on the Squaring Ramp and flush to the Horizontal Brace Channel.**

8. Position the Square Spacer between the Horizontal Brace Channel and the Right Leg so the holes line up.

➤ **Tip: You can pull back the right leg to make more room to place the Spacer.**



Spacer set between the Horizontal Material Bar and the Right Leg

# Installation

- Insert the one (1) M8 x 110mm Socket Cap Screw and two (2) Flat Washers through the Horizontal Material Bar and secure the one (1) Lock Nut using a 6mm Hex Key and 13mm Wrench.

◆ **Note:** Rotate the Spacer until it is flush with the Right Leg.

*(Free-Standing Unit assembly continues at “Inserting the Production Stops” – see Section 20.)*

## 19. Securing the Wall-Mounted Unit (Wall-Mounted Unit only)

**Parts Needed:**

Qty	Hardware	Tools Needed
2	M10 x 25mm Hex Head Bolt <i>(removed previously)</i>	Two (2) 17mm Wrenches

◆ **Note:** If you extended the Front/Back Support Bars for better workspace, fold the Bars back up and replace the long M10 Bolt.

- Locate the two (2) M10 x 25mm Hex Head Bolts that were previously removed when the Rear Leg was detached from the Vertical Track Assembly.
- Insert them into the bottom two holes on the Rear Leg Mounting Bracket.
- Tighten the Bolts using two (2) 17mm Wrenches.

◆ **Note:** Make sure the all the Bolts and Screws are tight, so the FSC won't move around during operation.

## 20. Inserting the Production Stops

**Parts Needed:**

Frame Parts
Left Production Stop Assembly
Right Production Stop Assembly

- Locate the Left Production Stop Assembly (it has the small Red and Silver Fingers).
- Loosen the black Knob.
- Ensure the Fingers are to the right of the Knob, and slide the Production Stop into the groove to the left side of the Horizontal Material Bar.

➤ **Tip:** If the Production Stop does not slide on easily, loosen the black Knob slightly.

- Repeat Steps 2 and 3 for the right Production Stop, sliding it onto the right side of the Horizontal Material Bar.

**Production Stops**

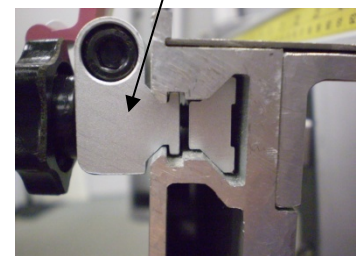

**View from the Right Side of the Horizontal Material Support Extrusion**

# Installation

## 21. Mounting the Tool Caddy

### Parts Needed:

Frame Parts	Qty.	Hardware	Tools Needed
	2	Screws	
Tool Caddy	2	Washers (packed with Tool Caddy)	Phillips-head Screwdriver

1. Locate the two (2) holes under the right side of the Horizontal Material Bar.
2. Align the holes on the top of the Tool Caddy with the holes under the right side of the Horizontal Material Bar.
3. Attach the Tool Caddy to the Horizontal Material Bar using the (2) Screws and (2) Washers provided in the Tool Caddy Box.
4. Tighten the Screws using a Phillips-head Screwdriver.

## 22. Squaring the FSC

1. Take a 1/4" thick piece of PVC or foamboard (approx. 32"H x 40"W) and place the straight edge on the Horizontal Material Bar. Measure it with a tape measure and mark it top and bottom at the halfway point (approximately 20").
2. Insert the 1/2" Blade Holder into the Cutting Head. Loosen the Slide Securing Knob and depress the Thumb Lever. Move the Cutting Head and the board so the mark on the board aligns with the Cutting Head. Clamp the board in place, depress the Thumb Lever, raise the Cutting Head and make two cuts. Make the first cut through the top of the board 1" long, and make the second cut through the bottom of the board 1" long.
3. Rotate the board 180° so the back is facing you and the board is resting on the same bottom edge as before. Slide it into the machine again. Align the blade with the bottom cut you made, which will now be visible from the reverse side of the board. Clamp the board into place. Depress the Thumb Lever, raise the Cutting Head and make a third cut 1" long at the top edge of the board.
4. If the machine is square, the two cuts at the top of the board (the second cut, made from the front and the third cut, made from the back) will be in alignment. Tighten the Hex Nut on the Ramp Adjusting Bolt at the left side of the machine. Then tighten the four (4) mounting screws on the Horizontal Material Bar.
5. **If the cuts you made on the front and back of the board do not align**, the machine is not square yet. The Horizontal Material Bar must be repositioned. If the third cut you made (the one made at the top on the back of the board) is to the **left** of the second cut you made (at the top of the board from the front), the Horizontal Material Bar must be lowered by making a ramp adjustment on the left side of the machine. Conversely, if the third cut you made (on the top of the back of the board) is to the **right** of the second cut (on the top of the front), the Horizontal Material Bar must be raised. In either case, the amount of squaring adjustment required is **half the distance between the two top cuts**. Once the machine is square, follow the step above (#4).

# Installation

## 23. Setting the Scales

1. Install a Blade Holder into the FSC.
2. Install the Production Stops. Loosen the right (larger) Production Stop Knob, slide onto the front of the Horizontal Material Bar from the right and tighten the Knob. Repeat with the other Production Stop, sliding it onto the left side.
3. Start with the Vertical Scale. Take a piece of foamboard or matboard exactly 6" x12" (measure with ruler or tape measure, and cut). Using a ruler or tape measure, mark 6" from the left side of the foamboard. Put the board on the machine and make sure the mark lines up with the 6" line on the Vertical Scale. Slide the scale to match if it does not line up. Friction should keep it in place, but if it moves too easily, apply double-sided tape behind it and firmly press it down to make it adhere.
4. When squaring the Horizontal Scales, start with the left one. Take your board and slide it into the machine until the 6" marking lines up with the blade. **Clamp the board so it doesn't move**, and adjust the scale to the left until it matches. **Use the SILVER Production Stop Lever if you are using one of the small Silver Blade Holders and the RED Production Stop Lever if you are using one of the large Wheel Holders** (the ones with the red tab on the end). Make sure the corresponding Blade Holder or Wheel Holder lines up with the correct measurement. Apply double-sided tape behind the left Horizontal Scale to make sure it doesn't move.
5. To set the right side Horizontal Scale, slide the foamboard into the machine and adjust the 6" line so the blade lines up over it. **Clamp the board so it doesn't move**, and adjust the scale to the left until it matches. **Use the SILVER Production Stop Lever if you are using one of the small Silver Blade Holders and the RED Production Stop Lever if you are using one of the large Wheel Holders** (the ones with the red tab on the end). Make sure the corresponding Blade Holder or Wheel Holder lines up with the correct measurement. Apply double-sided tape behind the right Horizontal Scale to make sure it doesn't move.
6. Cut the foamboard at the 6" mark and both pieces should be the same.

## 24. Adjust Vertical Track/Clamp Assembly

The Vertical Track Assembly consists of two parts – a stationary part and a moveable clamp. The clamp holds the material firmly against the stationary part so that the material does not move during the cutting stroke. If the material moves, or is not firmly held at the bottom, adjust the bottom eccentric assembly on the lower left side of the Vertical Track Assembly to apply proper clamping. If it moves or is not firmly held at the top, adjust the top eccentric assembly on the upper right side of the Vertical Track Assembly to apply proper clamping. This addendum describes the adjustment and verification procedures for both areas.

♦ **Note: In most cases, if material moves at either the bottom or top, adjust both identical eccentric assemblies (eccentrics). This ensures that there is no material slippage, the cutting stroke is even, and the need for repeating the procedure later for the other eccentric is eliminated.**

1. Remove material from the FSC.
2. Fold an 8½" x 11" sheet of paper so it creates a thickness of four (4) sheets (0.012").
3. Slide the folded paper between the center stationary part and the moveable clamp as shown at the right.

# Installation

4. Lower the Clamp Lever fully so that the stationary part and the moveable clamp are firmly together.
5. To verify clamping, attempt to remove the folded paper. If the paper cannot be removed, the center stationary part and moveable clamp have proper clamping. If the paper can be pulled out, adjust both the bottom and top eccentrics to provide proper clamping for this area.
6. Raise the Clamp Lever fully and remove the paper.
7. The bottom eccentric is shown at the right (*the top is identical in purpose and procedure*). Loosen the M6 Screw so that the 15mm Hex Head eccentric can be turned.
8. Slide the folded paper between the bottom stationary part and the moveable clamp.
9. Lower the Clamp Lever fully so that the stationary part and the moveable clamp are firmly together.
10. Turn the eccentric left or right while attempting to remove the paper from between the stationary part and the moveable clamp.
11. To verify clamping, attempt to remove the folded paper. When the paper cannot be removed, the eccentric is providing proper clamping. Tighten the M6 Screw so that the eccentric will not turn.
12. Raise the Clamp Lever fully and remove the paper.
13. The adjustment for the bottom eccentric is complete.
14. Repeat Steps 7 – 13 for the upper eccentric.
15. The adjustments for the eccentrics are completed. All the proper material clamping.



# Cutting Tools and Substrates

## II. Using Cutting Tools and Substrates

### 25. Cutting Blades and Wheels

◆ **Note:** Using the Blade Holder that is appropriate for the thickness of your material will minimize the possibility of blade deflection.

**A. ¼" (7mm) Blade Holder (optional)**

This blade holder is used for foamboard, Gatorboard, PVC, corrugated plastic and polycarbonate. Use this one for materials up to ¼" (7mm) thick.



**B. ½" (13mm) Blade Holder**

This blade holder is used for foamboard, gatorboard, PVC and corrugated plastic. Use this one for materials up to ½" (13mm) thick.



**C. Acrylic Blade Holder**

This blade holder cuts acrylic and other fracture-sensitive plastics, and polycarbonate up to ¼" (7mm) thick.



**D. Glass Scoring Wheel Holder (optional)**

This wheel holder is for scoring glass up to ¼" (7mm) thick.



**E. Aluminum Sheet Wheel Holder (optional)**

This wheel holder is for cutting solid aluminum sheet material up to .063" (1.5mm) thick. *(This Wheel Holder has RED marking on the rear edge that says 'Alum Sheet'.)*



**F. Aluminum Composite Wheel Holder**

This wheel holder is for cutting aluminum-faced sheet material up to ¼" (7mm) thick. *(This Wheel Holder has RED marking on the rear edge that says 'Alum Composite'.)*



# Cutting Tools and Substrates

## 26. Installing New Cutting Blades/Wheels/Scoring Tips into Holders



**CAUTION:** Blades are extremely sharp. Handle with care.

### A. 1/2" (13mm) or 1/4" (7mm) Blade

1. Loosen the Blade Clamp Screw on the Blade Holder using a Phillips-head Screwdriver.
2. Slide the notched end of the Cutting Blade into the holder so it nests on the Blade Stop Pin.

◆ **Note:** Make sure the Blade is fully embedded into the Blade Holder.

3. Tighten the Screw.

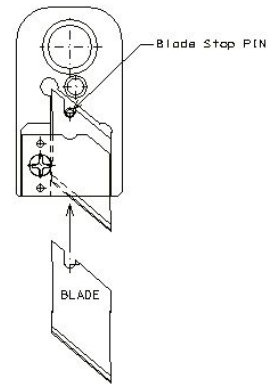

### B. Cutting Wheels

1. Position the Cutting Wheels so the beveled sides face out.
2. Place the Ball Bearings on the Wheel, and then the Screws.
3. Tighten the Screws.

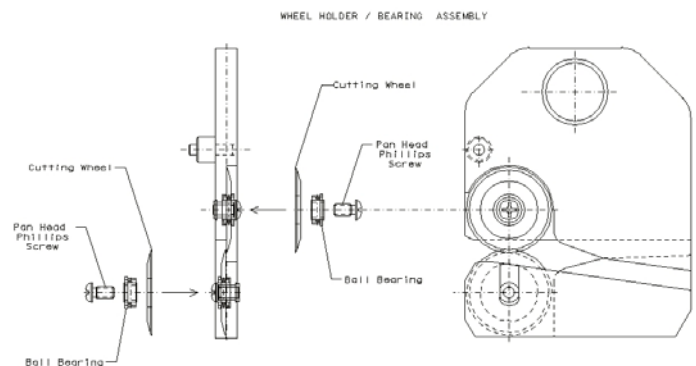

### C. Acrylic Blade

1. Loosen the Blade Clamp Screw on the Blade Holder.
2. Slide the notched end of the Cutting Blade into the holder from the left side of the Screw Head.

◆ **Note:** Make sure the Blade is fully embedded into the Blade Holder.

3. Tighten the Screw.

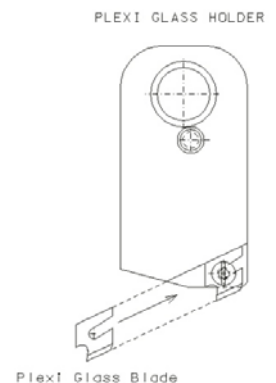



# Cutting Tools and Substrates

## D. Glass Scoring Wheel

1. Position the new Glass Scoring Wheel in the gap so the notch is positioned inward.
2. Gently rock it back-and-forth until it is firmly seated into place.

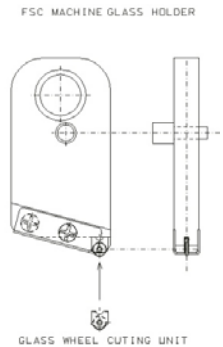

## 27. Cutting Techniques for Various Substrates

Each material you will use has its own unique characteristics. Whether it is brittle, soft, thick, or ridged in nature, you will need to choose the proper Cutting Blade/Wheel and technique to get the best results. **Refer to the “Cutting Blades and Wheels,” Section 25 on page 16, for more information on each Blade and Wheel Holder.**

◆ **Note:** To learn how to load the Blade/Wheel Holders, and all other general use information, please refer to “Operating the FSC” beginning on page 19.

### A. Cutting Foamboard/Gatorboard

1. Insert the ¼" (7mm) or the ½" (13mm) Blade Holder (*refer to “Cutting Blades and Wheels,” Section 25 on page 16 for proper Blade*) into the Cutting Head.
2. Lock the Holder Securing Knob.
3. Clamp the substrate in place.
4. Depress Thumb Lever and raise the Cutting Head above the material.
5. Release Thumb Lever and engage Rocker Arm Locking Pin to secure the Blade in the forward position. (*See “Locking the Rocker Arm,” Section 36 on Page 23 for more information.*)
6. Pull the Cutting Head down in one continuous movement.

◆ **Notes:**

- A fresh Blade should cut the material in one pass.
- Production Stop should be used if making more than one piece of the same size.

### B. Cutting PVC and Corrugated Plastic

1. Insert the ¼" (7mm) or ½" (13mm) Blade Holder (*refer to “Cutting Blades and Wheels” Section 25 on page 16 for proper Blade*) into the Cutting Head.
2. Lock the Holder Securing Knob.
3. Clamp the substrate in place.
4. Depress Thumb Lever and raise the Cutting Head above the material.
5. Release the Thumb Lever and engage the Rocker Arm Locking Pin to secure the Blade in the forward position. (*See “Locking the Rocker Arm,” Section 36 on Page 23 for more information.*)
6. Pull the Cutting Head down in one continuous movement.
  - **Tip:** For thinner material, such as polycarbonate, place a piece of sacrificial material behind it to avoid slippage.



# Cutting Tools and Substrates

◆ Notes:

- **Production Stop** should be used if making more than one piece of the same size.
- **Thinner materials** can be cut with one pass, but thicker materials will take more than one pass to cut through material.

## 28. Scoring and Breaking Techniques for Fracture-Sensitive Material

◆ Note: It is not necessary to remove the protective coating prior to cutting.

### A. Scoring Fracture-Sensitive Material and Polycarbonate

1. Insert the Acrylic Blade Holder into the Cutting Head.
2. Lock the Holder Securing Knob.
3. Clamp the substrate in place.
4. Depress Thumb Lever and raise the Cutting Head so the Blade is positioned approximately 1/32" (1mm) from the top edge of the material.
5. Using the Dual Handle, pull down **slowly** to its resting position.

◆ Note: Traveling slowly will create a smoother, more polished edge.

Material	Cutting Technique
1/8" (3mm) thick	One pass with a fresh blade
1/4" (7mm) thick	Make three or four passes

### B. Breaking Fracture-Sensitive Material

1. Apply pressure on the right side of the material to run the score and separate the pieces.

◆ Note: When cutting thicker Polycarbonate material, you will need to make multiple passes.

## 29. Cutting Solid Aluminum / Aluminum-Faced Sheet Material

1. Insert appropriate Wheel Holder into the Cutting Head. (*See "Cutting Blades and Wheels," Section 25 on page 16, for more information.*)
2. Raise the Cutting Head above the material, and then lock the Cutting Head in that position.
3. Set the Production Stops to the appropriate dimension.
4. Position the material up against the Production Stop and apply the Clamp.
5. Unlock and lower the Cutting Head until the Cutting Wheels contact the edge of the material.
6. Using the Dual Handle, firmly pull the Cutting Head down to its resting position.
7. Release the clamp.

◆ Note: Do not lift up on the Cutting Head and strike the edge of the material to get more force.

# Cutting Tools and Substrates

## Proper Glass Scoring and Breaking Techniques



### CAUTION:

- ☑ Always wear eye protection, gloves, and protective clothing when handling glass.
- ☑ Always load glass from the left side of the machine.
- ☑ Glass should not extend beyond the edges of the Horizontal Material Bar.
- ☑ Always score in a downward stroke.

### A. Scoring Glass

#### ◆ Notes:

- Never score the same place more than once.
- A light, continuous score line is best.
- If there is too much pressure, the score line will be flaky

1. Insert the Glass Scoring Wheel Holder into the Cutting Head.
2. Position the glass sheet on the left side of the Horizontal Material Bar.
3. Align the left edge of the glass with the desired measurement on the scale.
4. Gently apply the Clamp.
5. Grasp the handle, depress the Thumb Lever, and raise the Cutting Head well above the glass.
6. Release the Thumb Lever, and bring the Cutting Head down until you feel the Wheel Ramp contact the glass.
7. Bring the Cutting Head down to the resting position using one continuous motion.

➤ **Tip:** *If the glass is flaky there is too much pressure on the Rocker Arm. Refer to "Adjusting the Rocker Arm," Section 44.-B. on page 28 for more information.*

### B. Breaking Glass Along a Score Line

- ◆ Note: For proper breakout of glass, there must be at least 2<sup>3</sup>/<sub>4</sub>" (69.8 mm) to the right of the score line. Smaller sections must be removed from the machine and broken out on your workbench.



### CAUTION: Do not apply pressure at the center of the glass.

1. Place your thumb at the bottom right corner of the glass.
2. Apply just enough pressure until the glass breaks.
3. Release clamp.

# Operating the FSC

## III. Operating the FSC

### 30. Inserting the Cutting Tool in the Cutting Head

1. Raise the Cutting Head to a comfortable level by grabbing either the Dual Handle Bar, or the black Handle. Hold the Cutting Tool so the Blade Screw is to your right.
2. Insert the Blade Holder so the small tab on the left side of the Blade Holder is positioned in the notch of the Cutting Head above the Dual Handle Bar.
3. Secure the Holder by tightening the Holder Securing Knob.
4. Lower the Cutting Head to its resting position at the base of the Vertical Track Assembly.

◆ **Note:** The Holder Securing Knob must hold each Blade/Wheel Holder firmly in place.

### 32. Securing the Material

The Clamp will hold the substrate in place during the cutting process. This will allow the proper dimensions to be maintained.

#### A. To Close

1. Grasp the black Handle on the Vertical Track Assembly.
2. Pull the Handle down to its closed position.

#### B. To Open

1. Grasp the black Handle on the Vertical Track Assembly.
2. Pull the Handle up to its opened position.
  - **Tip:** *If the material does not slide easily between the Vertical Track Assembly and the Clamp Assembly, check to make sure the Clamp is fully open.*

### 33. Positioning the Substrate

1. Place the material on the Horizontal Material Bar and slide it under the Vertical Track Assembly.

◆ **Note:** It is best to load the material from left to right.

2. Position the material so that the left edge of the board aligns with the desired cutting dimension.
3. Lower the Clamp Lever to secure the material in place. (See “Securing the Material,” Section 32, for more information about the clamp mechanism.)
  - **Tip:** *If you are using a very thin substrate, place a piece of sacrificial material behind it to increase the tension on the clamp.*

# Operating the FSC

## 34. Using the Production Stops

◆ **Note:** Always use the Silver Stop Levers Fingers with the Blade Holders, and the Red Stop Levers Fingers with the Wheel Holders.

1. Unscrew the black Locking Knob.
2. Slide the Production Stops to the desired location.
3. Tighten the Locking Knob to secure the position.
4. Set the Silver Lever Fingers to the desired position. Flip up the Silver Fingers after setting to position the material for use with the Wheel Holders.

➤ **Tip:** If the Production Stop does not slide on easily, loosen the black Knob slightly.

## 35. Making a Cut or Score Line with the FSC

Please refer to “Using Cutting Tools and Substrates,” beginning on page 14 for specific information on the substrate you are cutting.

◆ **Note:** All cutting and scoring is done with a downward stroke.

### A. Creating a Cut Line

1. Grasp the handle of the Cutting Head.
2. Depress the Thumb Lever to raise the “Knife” Blade.
3. Pull the Cutting Head up above your material.
4. Position the Blade on top of the substrate, release the Thumb Lever, and pull down in a continuous movement until the Cutting Head is returned to its resting position.

◆ **Note:** Some materials may require a slower downward motion. Please consult “Cutting Techniques for Various Substrates” on page 16.

### B. Using a Blade to Create a Score Line

◆ **Note:** For harder substrates, follow the instructions for “Scoring Fracture-Sensitive Material,” Section 28.-A. on page 19 or “Proper Glass Scoring and Breaking Techniques” Section 30 on page 20.

1. Grasp the handle of the Cutting Head.
2. Depress the Thumb Lever to raise the Blade.
3. Position the Blade so it is resting on top of the material.
4. Ease up on the Thumb Lever, but do not release it all the way. This allows the Blade to be in contact with the material, but not to completely cut through.
5. Pull down in a continuous movement until the Cutting Head is returned to its resting position.

# Operating the FSC

## 36. Locking the Rocker Arm

The Rocker Arm Locking Pin secures the Blade in the cutting position. This ensures a consistent cut. It is recommended that the Rocker Arm Locking Pin be enabled on all final cutting passes.

### A. To Lock

1. Move the Cutting Head above the top of the substrate.
2. Locate the silver Rocker Arm Locking Pin on the right side of the Cutting Head.
3. Push it in to lock the Blade in the forward position.

### B. To Unlock

1. Pull the Rocker Arm Locking Pin out to be able to retract the Blade.

# Maintenance, Adjustments, Troubleshooting and FAQ

## IV. Installing the Laser

### 37. Setting Up the Laser

#### Tools Needed:

Tools Needed
10mm, 16mm, 17mm Wrenches 2mm, 2.5mm, 4mm 1/8" Hex Keys

1. Loosen the black Handle by turning it counterclockwise.
2. Slide the Laser all the way to the left along the Laser Shaft.
3. Ensure the brass-tipped Set Screw on the Laser Assembly is tight against the Laser Mount, and retighten the Handle.
4. Hold the Laser in the palm of your hand so the four (4) black Set Screws on the left side of the Laser are facing you.
5. Loosen the four (4) Set Screws using a 2mm Hex Key.
6. Tighten the center, mounting Screw using a 1/8" Hex Key.
7. Retighten the four (4) Set Screws **just** until they come in contact with the Laser.

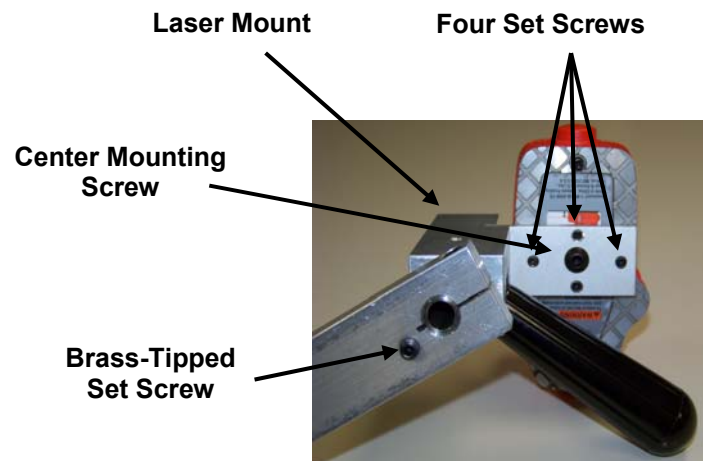

◆ **Note:** Do not over tighten the Set Screws. You will be making some fine adjustments to the Set Screws during calibration.

### 38. Mounting the Laser to the FSC

#### ◆ Notes:

- You will need a stepladder to complete this task.
  - Depending on your FSC model, there may already be a Bolt in the Laser Assembly Mounting Hole. Remove it using a 17mm Wrench.
1. Attach the Laser Assembly to the top, left-hand side of the Vertical Track Assembly (*see Figure to the right*).
  2. Insert and tighten the M10 x 35mm bolt supplied with the Laser using a 17mm Wrench.

M10 x 35mm Bolt attaching the Laser Assembly to the Vertical Track Assembly

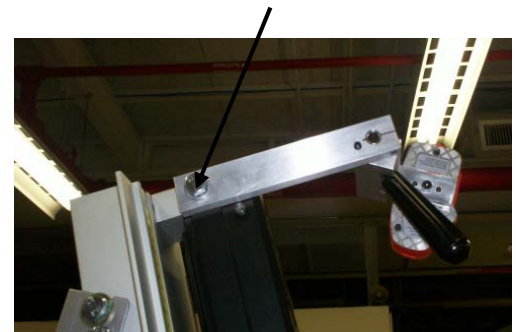

Vertical Track Assembly

# Maintenance, Adjustments, Troubleshooting and FAQ

## 39. Dual Position Laser

◆**Note:** The FSC cutting tool holders are sized for cutting performance. The “wheeled” tools are larger and provide an off-set cut line compared to the blade tool. The Laser Assembly is designed with a Dual Position feature giving you the ease of positioning the Laser Sight-Line to correspond to the cutting tool in use.



### A. Positioning the Laser for use with the Wheel

(Color-coded **RED**) (Aluminum and Aluminum Composite Material)

1. Loosen the black handle by turning it counterclockwise.
2. Slide the Laser all the way to the **RIGHT** along the shaft.
3. Tighten the black handle by turning it clockwise.

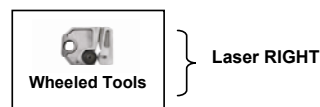

**RED** Laser Line enlarged for illustration only



### B. Positioning the Laser for use with the Blade

(**SILVER** Tools) (PVC, Foamboard, Coroplast, Acrylic)

1. Loosen the black handle by turning it counterclockwise.
2. Slide the Laser all the way to the **LEFT** along the shaft.
3. Tighten the black handle by turning it clockwise.

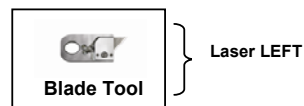

**RED** Laser Line enlarged for illustration only



## 40. Creating the Score Lines for Calibrating the Laser

1. Load a piece of sacrificial foamboard onto the Horizontal Material Bar. You can use another material if foamboard is not available.  
➤ **Tip: It is best to choose a softer material that will show the score lines better.**
2. Place the ½" (13mm) Blade Holder in the FSC.
3. Create a score line the entire length of the foamboard.
4. Remove the ½" (13mm) Blade Holder and replace it with the Aluminum Composite Wheel.

# Maintenance, Adjustments, Troubleshooting and FAQ

5. Place the Cutting Head at the top of the substrate and make a cut approximately 1" (2.5 mm) in length.
6. Remove the Aluminum Composite Wheel and return the Cutting Head to its resting position at the bottom Vertical Track Assembly.

## 41. Calibrating the Laser to Cut Lines



**CAUTION: Use Laser Safety Goggles before turning on the Laser.**

### A. Creating a Continuous Laser Beam

1. Turn on the Laser. The switch is located on the right side of the Laser. Slide the On/Off switch down to the On position.
2. If Laser Beam is visible from the top of the substrate to the bottom, skip to "Setting the Angle of the Laser Beam," Section 41.-B. on page 26.
3. If the Laser Beam is not entirely visible from the top of the substrate to the bottom:
  - a. Use a 4mm Hex Key, to loosen the Laser Shaft Clamping Screw located on the top of the Laser Shaft (*see Figure on the right*).
  - b. Rotate the Laser using the Handle until the beam becomes continuous from the top to the bottom of the substrate.
  - c. Retighten the Laser Shaft Clamping Screw.

Laser Shaft Clamping Screw



### B. Setting the Angle of the Laser Beam

Follow the steps below to create a beam that fall directly on top of your score line. Once your score line is perfectly matched up with the Laser Beam, you are finished.

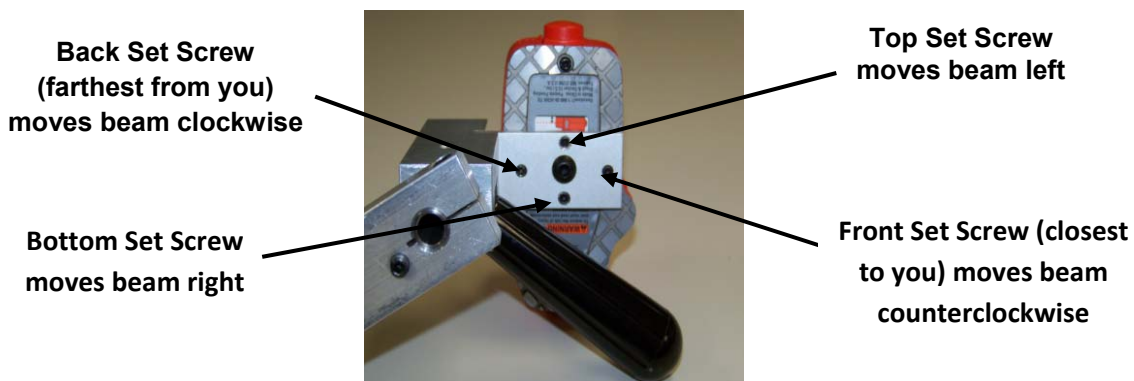



# Maintenance, Adjustments, Troubleshooting and FAQ

If the beam falls across your substrate from top left to bottom right, use a 2mm Hex Key to:

1. Tighten the bottom Set Screw and the beam will move to the right. When it is positioned over the top of the score line, stop tightening.
2. Tighten the back Set Screw and the beam will turn clockwise. When it is positioned over the score line, stop tightening.

◆ **Note:** You may need to continue to make slight adjustments.

**Bottom Set Screw  
moves beam right**

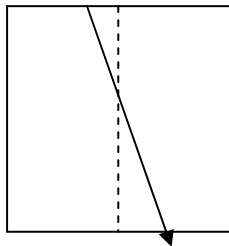

**Beam is diagonal  
to score line**

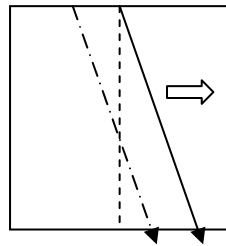

**Tightening bottom  
Set Screw moves  
beam right**

**Front Set Screw  
(closest to you) moves  
beam counterclockwise**

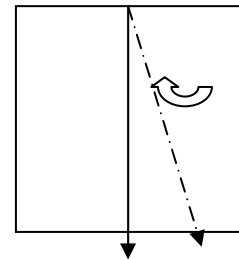

**Tightening back  
Set Screw moves  
beam clockwise**

If the beam falls across your substrate from top right to bottom left, use a 2mm Hex Key to:

1. Tighten the top Set Screw and the beam will move to the left. When it is positioned over the top of the score line, stop tightening.
2. Tighten the bottom Set Screw and the beam will turn counterclockwise. When it is positioned over the score line, stop tightening.

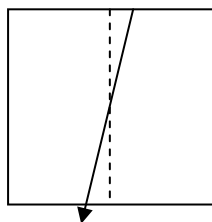

**Beam is diagonal  
right to left**

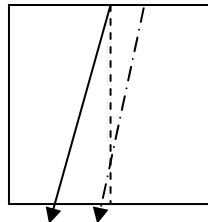

**Tightening top  
Set Screw moves  
beam left**

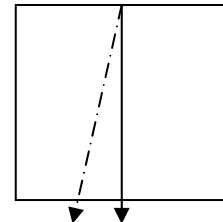

**Tightening front  
Set Screw moves  
beam counterclockwise**

Use the illustration above to help you adjust the beam until it is perfectly in line with the score line.

# Maintenance, Adjustments, Troubleshooting and FAQ

## 42. Securing the Blade Cutting Laser Position

1. Place a 2.5mm Hex Key in the brass-tipped Set Screw located on the top, left-hand side of the Laser Assembly, and a 10mm Wrench on the Hex Nut opposite the Screw.
2. Tighten the Screw to create the Blade Cutting Laser Position.

## 43. Securing the Cutting Wheel Laser Position

1. Loosen the Handle and move the Laser to the far right on the Laser Shaft.
2. If the beam is to the right of the Aluminum Composite Wheel cut line:
  - a. Slowly tighten the Nylock Bolt, located to the far right end of the Laser Shaft, using a 16mm Wrench.
  - b. When the beam is aligned with the wheel cut line, you are finished.
3. If the beam is to the left of the Aluminum Composite Wheel Cut line:
  - a. Loosen the Nylock Bolt, located to the far-right end of the Laser Shaft, using a 16mm Wrench.
  - b. Slide the Laser over to the right.
  - c. Continue to loosen and slide until the beam lines up with the cut line.
  - d. When the beam is aligned with the wheel cut line, you are finished.

**Nylock Bolt on  
the end of  
the Laser Shaft** →



# Maintenance, Adjustments, Troubleshooting & FAQ

## V. Maintenance, Adjustments, Troubleshooting & FAQ

### 44. General Maintenance Tips

#### A. Cleaning

With care and frequent cleaning, the FSC will remain in proper working order, and will perform indefinitely, as expected.

1. Clean the Horizontal Support Material Extrusion. If debris collects on the Bar, the substrate will not sit squarely, and will not cut straight.
2. Always use sharp cutting tools. Keep a supply of each of the cutting blades in a convenient place near the machine.
3. Keep the Vertical Track clean so the Cutting Head can move freely up and down.

#### B. Adjusting the Rocker Arm

After considerable use, it may become necessary to adjust the Rocker Arm. The Rocker Arm determines how much pressure each Cutting Tool applies to the material.

1. Insert the PVC Blade Holder into the Cutting Head.
2. Locate the Rocker Arm Adjusting Screw (gold-plated) under the dual handle bar.
3. Depress the Thumb Lever on the Cutting Head.
4. Turn the Rocker Arm Adjusting Screw so the tip of the Blade is past the Vertical Track Wear Strip by 1/8"-3/16" (3mm - 5mm).

◆ **Note:** If you need to make adjustments to the Glass Scoring Wheel Holder, turn the Adjusting Screw so the Glass Scoring Wheel is almost even with the top of the Vertical Track Wear Strip.

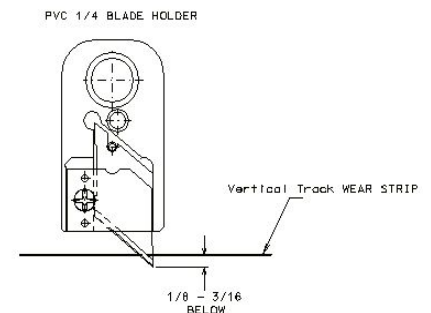

#### C. Adjusting the Cutting Head Bearings

If the Cutting Head moves side-to-side too much, the plastic bearings are worn or loose. You will need to make adjustments using the small (3mm) Hex Key Wrench to tighten the two (2) adjustment Screws on the front of the Cutting Head.

◆ **Note:** Remove any Blade/Wheel Holders before beginning the bearing adjustment.

1. Raise the Cutting Head to eye level to locate the Bearing Adjustment Screws (*see Figure on the right*).



# Maintenance, Adjustments, Troubleshooting & FAQ

2. Using the 3mm Hex Key Wrench, turn both Screws clockwise in increments of about one-eighth (1/8) of a revolution (**see Figure on the right**).
3. Check to see if the bearings are no longer loose by sliding the Cutting Head Assembly up and down the Vertical Track Assembly.
4. Repeat Step 2 and 3 above until both the lateral movement is minimized and the vertical movement of the Cutting Head is smooth.



## **D. Replacing the Cutting Head Bearings**

If adjusting the bearings doesn't work, you will need to replace two (2) round-shaped bearings at the back, and two (2) v-shaped bearings at the front of the Cutting Head Assembly. The chances of this are slim, so try the above adjustment before you replace the bearings.

◆ **Note: Remove any Blade/Wheel Holders before you remove the Cutting Head.**

## **E. Removing the Cutting Head**

1. Loosen the Locking Knob on the Cutting Head.
  2. Depress the Thumb Lever and raise the Cutting Head about 10" (254mm) above the Horizontal Material Bar.
  3. Locate the 10mm Hex Head Bolt on the bottom right side of the Vertical Track Assembly.
  4. Remove the bolt with a 17mm Wrench.
  5. Remove the black Bumper and the Stop Block. Loosen the Locking Knob.
- ◆ **Note: If the bumper is worn/damaged, you can replace it (see Section 47).**
6. Grasp the Handle and slide the Cutting Head off the bottom of the Vertical Track Assembly.

## **F. Removing the Bearings**

There are (3) three types of bearings and seven (7) black Flat Head Screws on the Cutting Head Assembly:

1. Two (2) round-shaped type (white) plastic bearings on the back.
2. Two (2) v-shaped type (white) plastic bearings on the front.
3. One (1) brake-type v-shaped bearing in the middle on the front.

◆ **Note: There are metal wear pads that are placed inside the v-shaped type bearings and brake-type v-shaped bearing. These metal wear pads must be assembled the same way in the new bearings and are necessary for proper adjustment and braking of the Cutting Head Assembly.**

1. Remove the Screws using a 2.5mm Hex Key.
2. Remove each Bearing and replace it with new Bearings.
3. Replace the Flat Head Screws.
4. Remount the Cutting Head Assembly onto the Vertical Track Assembly.

# Maintenance, Adjustments, Troubleshooting & FAQ

5. Reinstall the black Bumper, Stop Block, and 10mm Bolt. Repeat the adjustments as describe in “Adjusting the Cutting Head Bearings,” Section 44.-C. on page 28.

## VI. Troubleshooting Your FSC

If this **Troubleshooting Guide** or the **Frequently Asked Questions** listed below does not answer your questions, call our Customer Service Department at 1.800.843.3826 (within the United States) or outside the United States, call ++800.843.3826, visit our website ([www.fletcher-terry.com](http://www.fletcher-terry.com)) or send an email to [customerservice@fletcher-terry.com](mailto:customerservice@fletcher-terry.com).

Symptom	Probable Cause	Correction
Plastic Scoring Chatters	Too Much Pressure Scoring Too Fast	Loosen the Pressure Knob Slow the Scoring Stroke
Ragged Cut Edge When Cutting Thin Material	No Sacrificial Sheet	Use New Sacrificial Sheet
Ragged Edges	Cutting Blade is Dull	Use New Sacrificial Sheet
Not Cutting Squarely	Foreign Material on Horizontal Support Horizontal Material Support Bar is Not Installed Properly	Clean Adjust Bar (see page 11)
Can't Depress the Thumb Lever	Rocker Arm Locking Pin is engaged	Disengage the Locking Pin
Glass is flaking	Too Much Pressure	Loosen the Pressure Knob
Cutting Head is Moving Side-to-Side	Cutting Head Bearings have loosened	“Adjusting the Cutting Head Bearings”, (see Section 44.-C. on page 28)

# Maintenance, Adjustments, Troubleshooting & FAQ

## VII. Frequently Asked Questions

### A. Materials

**Q: *What is the best way to cut corrugated plastic?***

A: When cutting across corrugated plastic flutes, cut in a single pass. When cutting in the direction of the flutes, position the blade between the flutes to avoid blade deflection. Use the Rocker Arm Locking Pin to help avoid deflection.

**Note: Thicker material may require multiple passes.**

**Q: *Why do I get a jagged edge when I cut foamboard?***

A: There are two critical elements of cutting foamboard materials. First, always use a sharp blade. Second, maintain a minimum blade exposure when cutting through the foamboard.

For example: If you are frequently cutting thinner material, such as 3/16" or 1/4", we recommend the 1/4" Blade Holder.

**Q: *Why does my Aluminum Cutting Wheel cut .063", but not .04" aluminum? Am I doing something wrong?***

A: The FSC is designed to cut aluminum up to .063. Check that you are using the proper tool. The wheel holder is clearly marked "Alum Sheet" in red. If you are still experiencing problems, please contact Customer Service at 1.800.843.3826.

**Q: *I frequently get a jagged edge when cutting PVC material. What is the best way to cut?***

A: When cutting PVC it is important that you cut through the material slowly. What creates the jagged edge is excessive speed when passing the "knife" blade through the material. If you hear a zipper-type sound, you're going too fast. We recommend that you go slowly, and cut in multiple-passes exerting a little more pressure with each pass.

**Q: *Can I cut MDO and MDF on the FSC?***

A: No. The FSC is designed to cut plastic-based materials, paper, aluminum (sheet and composite), acrylics, and glass.

# Maintenance, Adjustments, Troubleshooting & FAQ

## **B. Cutting**

**Q: *What is the FSC's cut capacity?***

A: The FSC has a vertical height cut capacity of 65" and can cut up to ½" thick materials.

**Q: *Why are the Production Stops color-coded?***

A: The red stop is for sheet aluminum and the aluminum composite material and the silver stop is for all other material.

**Q: *How long do the blades and wheels last?***

A: All Fletcher cutting blades and wheels are "Extended Life" blades/wheels. The life of the cutting edge is directly correlated to the type of material being cut. For instance, cutting plastic type materials (PVC, corrugated plastics, etc.) tend to self-hone the edge, and will last hundreds of passes. Conversely, paper-based materials are inherently abrasive, and will dull a cutting edge faster.

**Q: *Can I cut horizontally on the FSC?***

A: No. The FSC is a vertical substrate cutter with a vertical capacity of 65".

# Replacement Parts List And Schematics

## VI. Replacement Parts List & Schematics

**NOTE: Our Replacement Parts List and Schematics are in the final stages and will be posted on our website ([www.fletcher-terry.com](http://www.fletcher-terry.com)) when they become available. In the meantime, if you need technical support, contact our customer service department at:**

**888.888.5165 (in the United States)  
++860.677.7331 (outside the United States)  
email - [customerservice@fletcher-terry.com](mailto:customerservice@fletcher-terry.com)**